

THE INFORMATION CONTAINED IN THIS DRAWING IS THE SOLE PROPERTY OF ABBOTT WORKHOLDING PRODUCTS. ANY REPRODUCTION IN PART OR WHOLE WITHOUT THE WRITTEN PERMISSION OF ABBOTT WORKHOLDING PRODUCTS IS PROHIBITED.

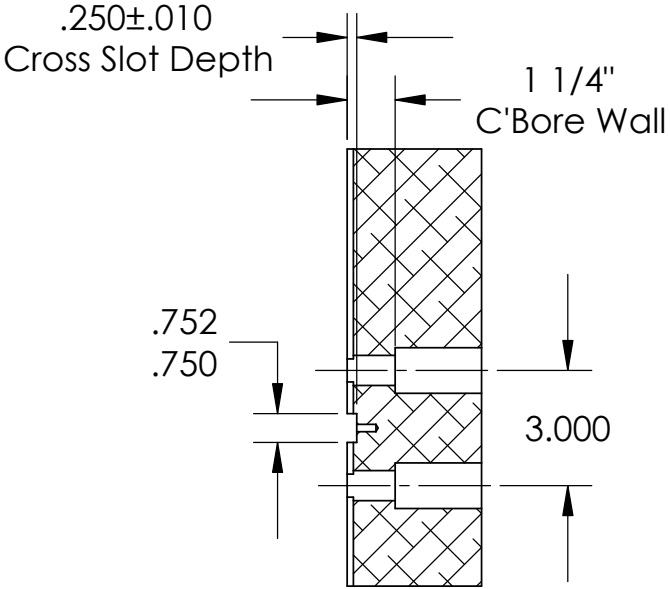
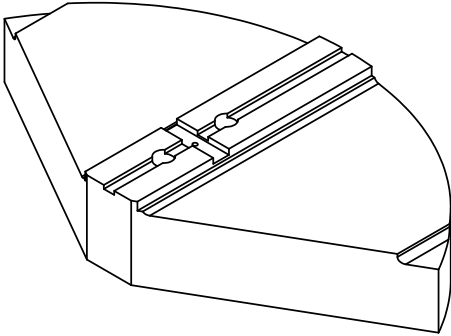
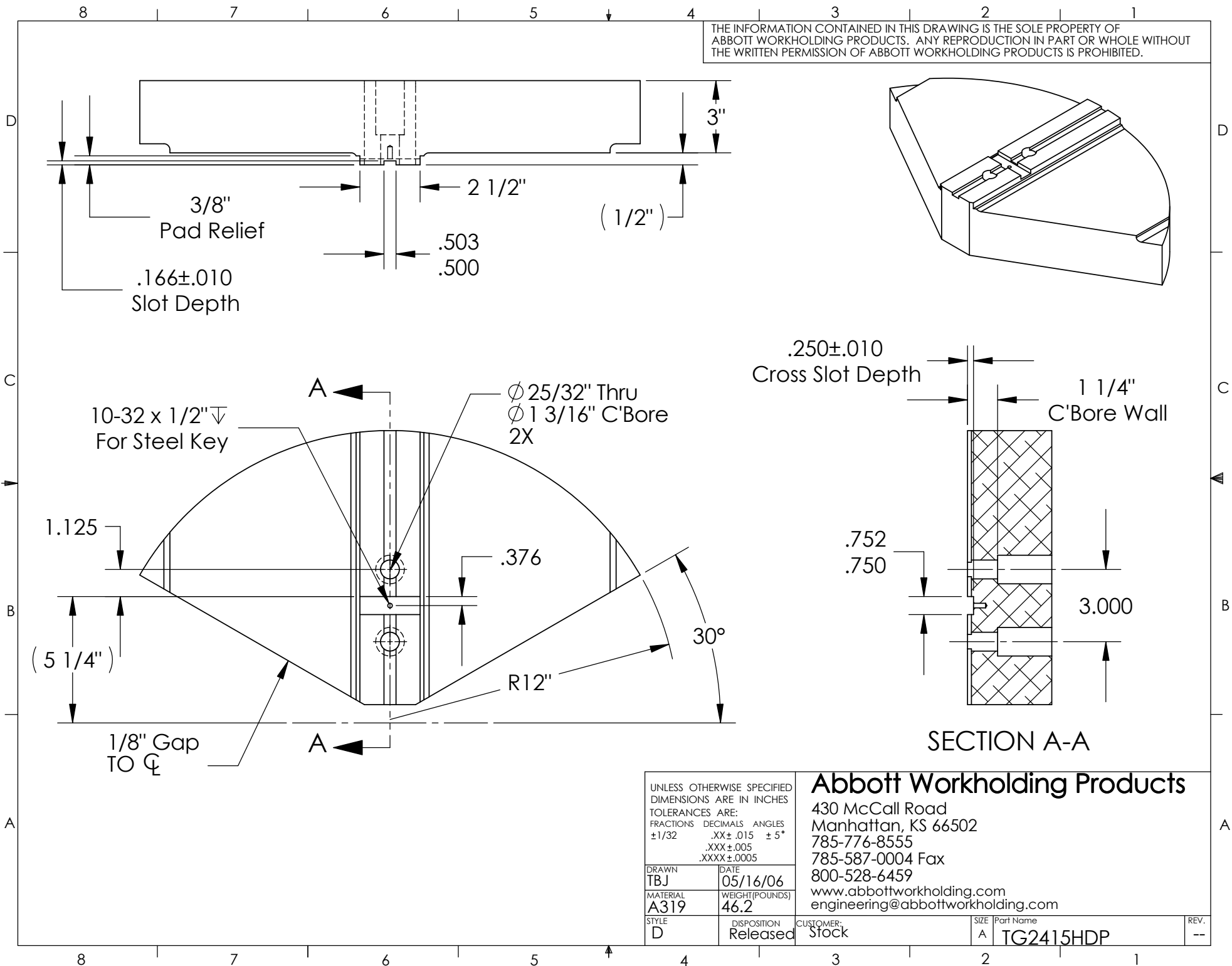

SECTION A-A

UNLESS OTHERWISE SPECIFIED DIMENSIONS ARE IN INCHES TOLERANCES ARE: FRACTIONS DECIMALS ANGLES ±1/32 .XX±.015 ±5° .XXX±.005 .XXXX±.0005	
DRAWN TBJ	DATE 05/16/06
MATERIAL A319	WEIGHT(POUNDS) 46.2
STYLE D	DISPOSITION Released

**Abbott Workholding Products**

430 McCall Road  
 Manhattan, KS 66502  
 785-776-8555  
 785-587-0004 Fax  
 800-528-6459  
 www.abbottworkholding.com  
 engineering@abbottworkholding.com

CUSTOMER: Stock	SIZE A	Part Name TG2415HDP	REV. --
--------------------	-----------	------------------------	------------