

THE INFORMATION CONTAINED IN THIS DRAWING IS THE SOLE PROPERTY OF ABBOTT WORKHOLDING PRODUCTS. ANY REPRODUCTION IN PART OR WHOLE WITHOUT THE WRITTEN PERMISSION OF ABBOTT WORKHOLDING PRODUCTS IS PROHIBITED.

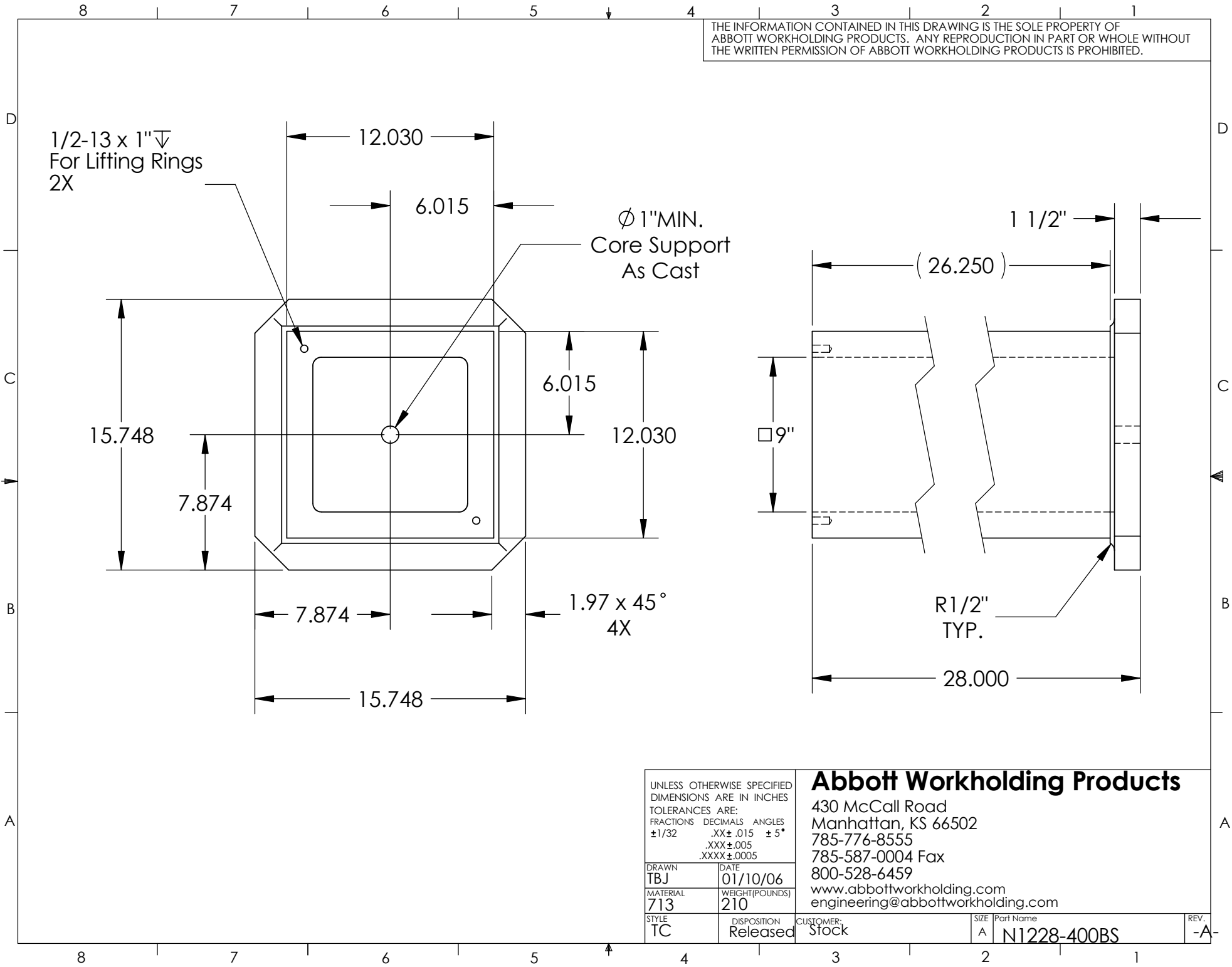

UNLESS OTHERWISE SPECIFIED  
DIMENSIONS ARE IN INCHES  
TOLERANCES ARE:  
FRACTIONS DECIMALS ANGLES  
±1/32 .XX±.015 ±5°  
.XXX±.005  
.XXXX±.0005

DRAWN TBJ	DATE 01/10/06
MATERIAL 713	WEIGHT(POUNDS) 210
STYLE TC	DISPOSITION Released

### Abbott Workholding Products

430 McCall Road  
Manhattan, KS 66502  
785-776-8555  
785-587-0004 Fax  
800-528-6459  
www.abbottworkholding.com  
engineering@abbottworkholding.com

CUSTOMER: Stock	SIZE A	Part Name N1228-400BS	REV. -A-
--------------------	-----------	--------------------------	-------------