

8 7 6 5 4 3 2 1

THE INFORMATION CONTAINED IN THIS DRAWING IS THE SOLE PROPERTY OF ABBOTT WORKHOLDING PRODUCTS. ANY REPRODUCTION IN PART OR WHOLE WITHOUT THE WRITTEN PERMISSION OF ABBOTT WORKHOLDING PRODUCTS IS PROHIBITED.

NOTES: Unless otherwise specified.

- 1. Machined surfaces \perp .001 in 12" // .002 in 12" \square .001 in 12"
- 2. Deburr and break all sharp edges.

Includes N12TP Top Plate And (2) Lifting Rings Installed

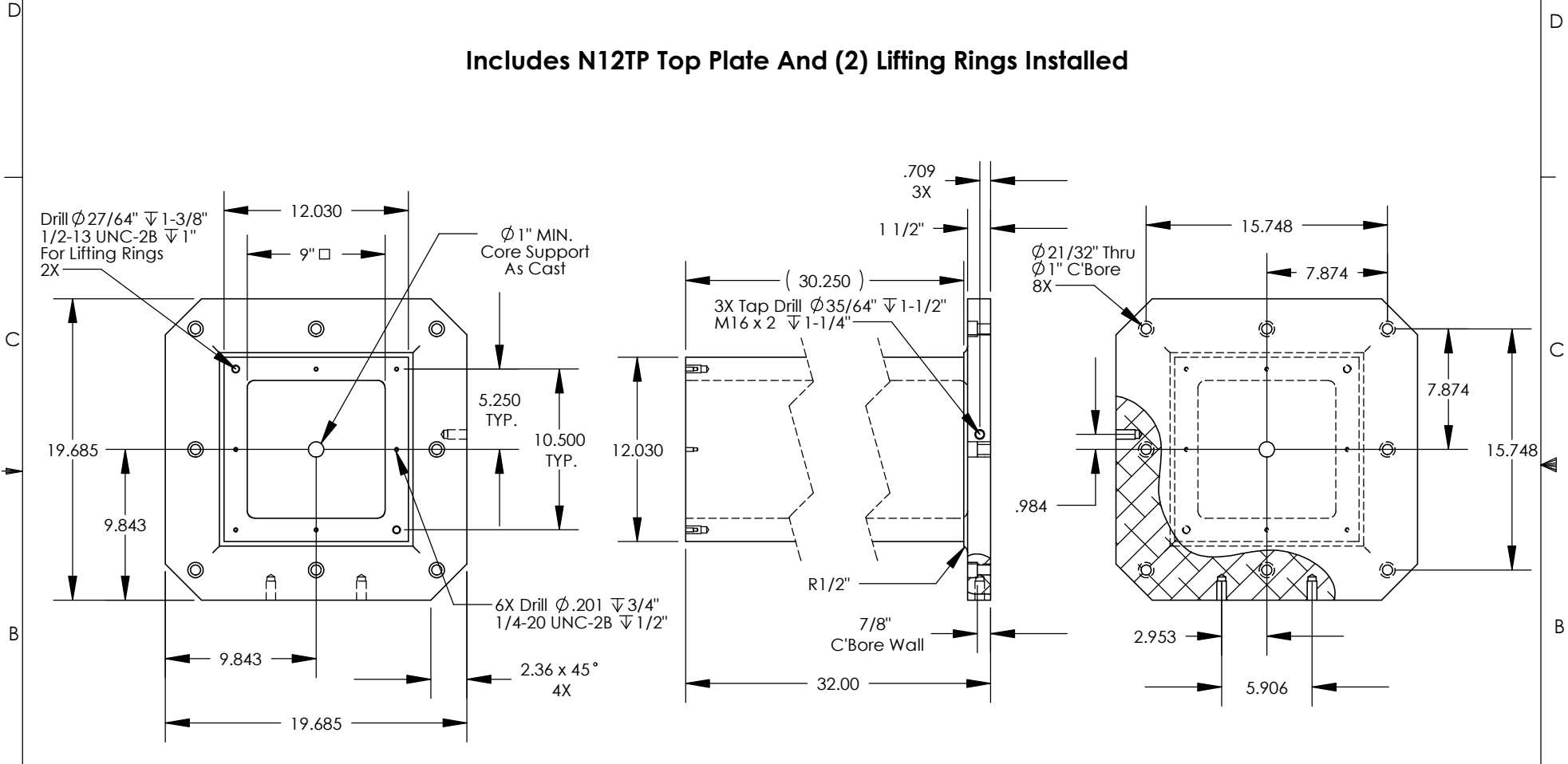

A

UNLESS OTHERWISE SPECIFIED DIMENSIONS ARE IN INCHES TOLERANCES ARE: FRACTIONS DECIMALS ANGLES ±1/32 .XX±.015 ±5° .XXX±.005 .XXXX±.0005	
DRAWN ZGG	DATE 05/09/19
MATERIAL 713	WEIGHT(POUNDS) 256.3
STYLE TC	DISPOSITION Released

Abbott Workholding Products

430 McCall Road
Manhattan, KS 66502
785-776-8555
785-587-0004 Fax
800-528-6459
www.abbottworkholding.com
engineering@abbottworkholding.com

CUSTOMER: Stock	SIZE Part Name A N1232-500JIS	REV. --
--------------------	----------------------------------	------------

8 7 6 5 4 3 2 1